

1 Prepare Light Fixtures

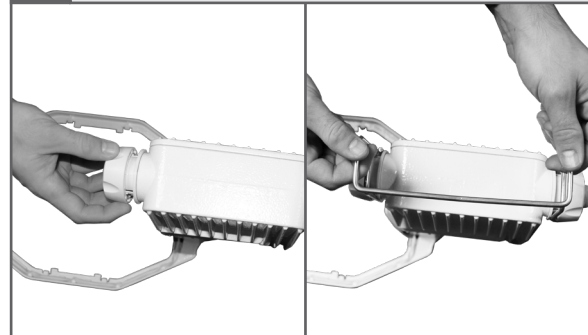

- Arrange boxed light fixtures on floor in specified mounting locations; remove fixtures from boxes.

2 Attach Mounting Brackets



- Turn bracket knobs on fixture counter-clockwise to loosen.
- Slide wire bracket beneath the knobs.
- Rotate knobs clockwise to tighten, securing bracket in place.

3 Insert Reflector into Collar

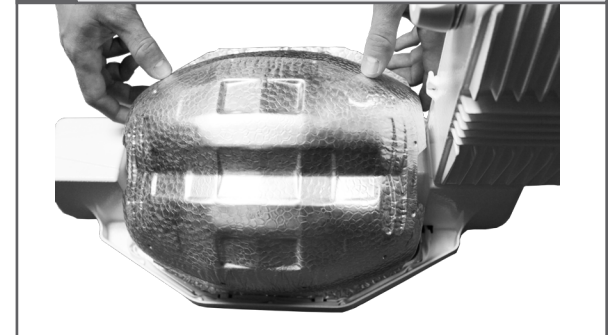

- Slide reflector into collar at an angle, so that outer rim is inserted beneath the collar tabs.
- (Note: Wear cotton gloves or wash hands thoroughly with soap & water to remove any grime/oils before handling reflector.)*

4 Adjust and Secure Reflector

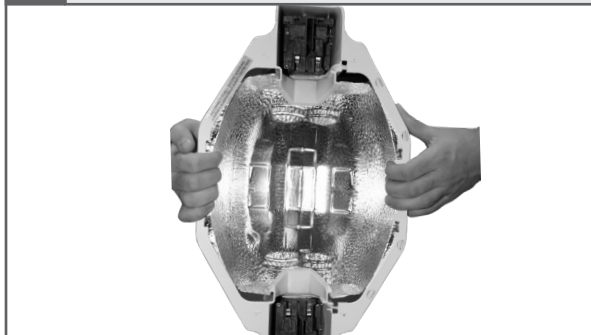

- Using both hands, adjust the reflector from the inside, by gently pressing outwards until the outer rim fits securely beneath the collar tabs on all sides.

(Note: Wear cotton gloves or wash hands thoroughly with soap & water to remove any grime/oils before handling reflector.)

! IMPORTANT

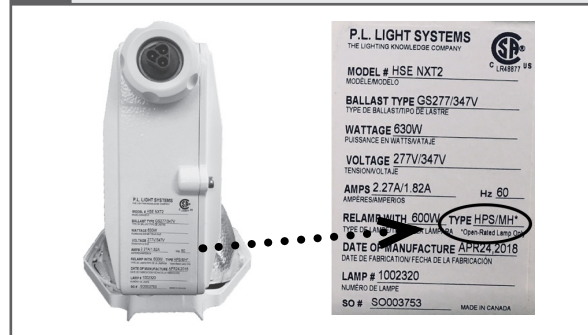

- Always check the fixture label prior to installing a Metal Halide (MH) lamp to ensure your fixture is compatible.
- Always ensure that the lamp is “open-rated” when installing a MH lamp.

5A Install Lamp

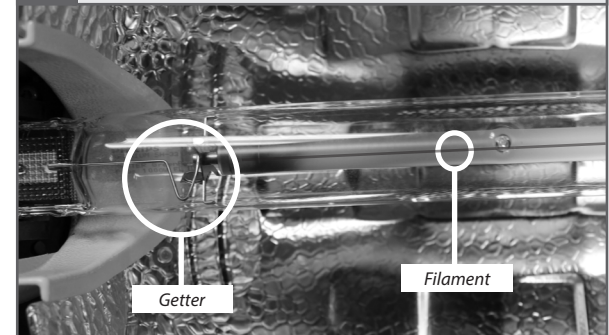

- Slide the plastic locks outwards.
- Install lamp, ensuring side with “getter” is closest to electronics compartment. If lamp is HPS, ensure burner filament is on top (away from reflector).

(Note: Always wear cotton gloves when handling double-ended lamps.)

! ATTENTION: Install in accordance with national and local building and electrical codes. !



5B IMPORTANT

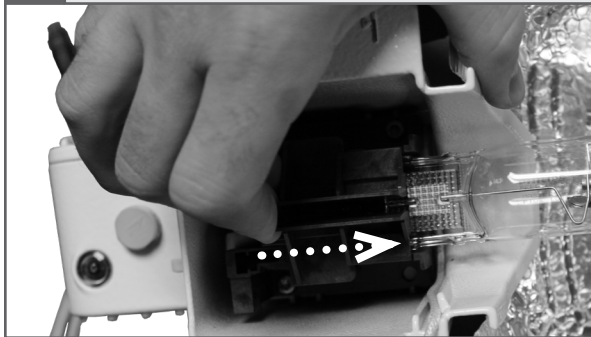

- Slide locks back in place to secure lamp.
- Ensure that the sliding mechanism has fully closed against the stop, as loose connections may cause arcing—potentially creating a fire risk and/or voiding warranties.

8 Level Fixture



- Use integrated level on back of the housing to adjust the light fixture. Fixture is level when spirit level bubble is centered.

6 Install Connector Box (Wieland Option ONLY)



Note: This step is for **Wieland Connector power cord option ONLY.**

- Install Wieland connector box / receptacle (sold separately) in suitable locations.

7 Mount Fixture

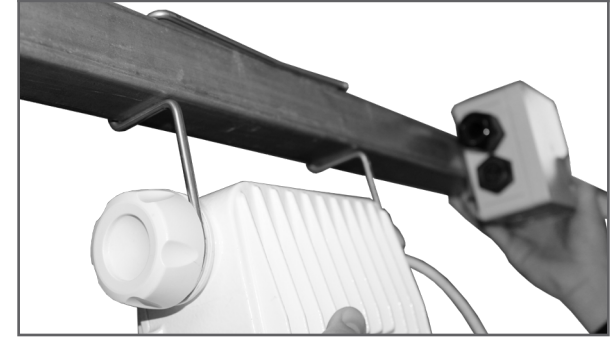

- Raise fixture to ceiling and slide mounting bracket over the track/truss; ensuring fixture is securely in place.

9 Complete Electrical Connection



- Connect power cord from fixture to power supply.

! ATTENTION: Install in accordance with national and local building and electrical codes. !